

SERVICE-DOCUMENTATIE

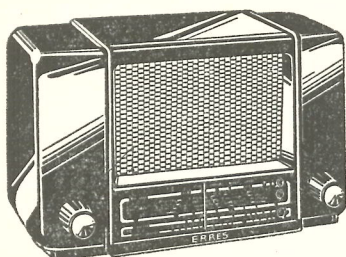

KY 553
KY 5531
KY 5532

Ontvangstoestellen voor
wissel en gelijkstroom

KY 5531 }
KY 5532 } Tropenbestendig



ERRES RADIO

I. A L G E M E N E G E G E V E N S

- a. Golfbereiken:
- | | | | | |
|---------|---------------|------|----|--------|
| KY 553 | Korte golf | 13,4 | - | 52 m |
| | Midden golf | 185 | -- | 585 m |
| | Lange golf | 950 | - | 1950 m |
| KY 5531 | Korte golf I | 13,4 | - | 42 m |
| | Korte golf II | 40 | -- | 140 m |
| | Midden golf | 185 | -- | 585 m |
| KY 5532 | Korte golf I | 13,4 | - | 42 m |
| | Korte golf II | 40 | -- | 140 m |
| | Lange golf | 950 | - | 1950 m |
- b. Buizen:
- | | | |
|-----|-----|----|
| B 1 | UCH | 81 |
| B 2 | UF | 41 |
| B 3 | UBC | 41 |
| B 4 | UL | 41 |
| B 5 | UY | 41 |
- c. Kringen:
- Afgestemde HF kringen: 1 + 1
Afgestemde MF kringen: 2 + 2
- d. Middenfrequentie: Nominaal 453 kHz
- e. Gevoeligheid: Beter dan 10 μ V
- f. Uitgangsvermogen: 1,8 W bij 10% vervorming gemeten bij 400 Hz.
- g. Selectiviteit: De M.F. bandbreedte voor 10voudig signaal bedraagt 11 kHz.
- h. Netspanningen: Omschakelbaar voor netspanningen van 127 V en 220 V.
- i. Bedieningsorganen: Volumeregelaar + netschakelaar
Golfbereikschakelaar
Afstemming
- j. Afmeting kast: 300 x 141 x 191 mm
- k. Gewicht: Bruto 5 kg; Netto 3 kg.

II. SPANNINGEN EN STROMEN

	B 1 UCH 81	B 2 UF 41	B 3 UBC 41	B 4 UL 41	
Va	172	172	56	190	Volt
Vg scherm	102	102		172	Volt
Vg	-1,8	-1,3	-1,7		Volt
Va triode	105				Volt
Ia	3	7,5		44,5	mA
Ig scherm	3,7	5,3		8	mA

$V_{C17}=200$ Volt; $V_{C18}=170$ Volt.

III. TRIM VOOR SCHRIFT

Meetzender: 30% moduleren met 400 Hz.

Wijzerinstelling: Variabele condensator geheel uitdraaien, wijzer instellen op begin van de schaal. Draaiingshoek var. condensator $172,5^\circ$.

Trimpunten: De volgende trimpunten zijn op de schaal aangegeven:
 KY 553 $8,3^\circ - 35^\circ - 152^\circ$
 KY 5531 $8,3^\circ - 152^\circ - 160^\circ$
 KY 5532 $8,3^\circ - 35^\circ - 152^\circ - 160^\circ$.

Afregelen: Volumeregelaar op maximum.

De volgorde van afregelen is: KY 553 LG - MG - KG.
 KY 5531 MG - KG2 - KG1.
 KY 5532 LG - KG 2- KG1.

Bereik	Meet-frequentie	Condensator-stand	Aansluiting	Afregelen	
				Osc. kring	Ant. kring
MF	450 Kc	180° MG (180° KG2 KY 5532).	via cond. van 22000 pF op g_1 UCH 81	Resp. S26/S25 S24/S23	
MF antenne filter	450 Kc	180° MG (180° KG2 KY 5532).	via 22000 pF op top van MG (KG2)	Beide kernen uitgedraaid S33/S32	
KG KY 553	6,5 Mc 22 Mc	152° $8,3^\circ$	via kunst- antenne	S13 C22	S4 C9
KG1	7,5 Mc 22 Mc	152° $8,3^\circ$	via kunst- antenne	S16 C22	S6 C41
KG2	2,3 Mc 7,5 Mc	160° $8,3^\circ$	via kunst- antenne	S18 C44	S8 C42
MG	570 Mc 1600 Mc	152° $8,3^\circ$	via kunst- antenne	S20 C23	S9 C8 C43 KY 5531
LG	166 Kc 300 Kc	152° 35°	via kunst- antenne	S22 C24	S10 C7

S p o e l e n e n T r a f o ' s

S 3	27 W	4,5 Ω	ant.spoel	S21	34 W	4,5 Ω	osc.spoel
4	12 W	1 Ω	13,5-52m	22	180 W	13,5 Ω	720-2000m
			GK 567 72				GK 568 21
5	26 W	< 1 Ω	ant.spoel	23	175 W	4,5 Ω	M.F.I trafo
6	9 W	< 1 Ω	13,5-42m	24	260 W	7,4 Ω	GK 567 95
			GK 567 71	25	175 W	4,5 Ω	M.F.II
7	115 W	7 Ω	ant.spoel	26	260 W	7,4 Ω	trafo
8	42 W	1 Ω	40-140m				GK 567 95
			GK 568 59	27	2100 W	375 Ω	Uitgangs-
9	61 W	1,3 Ω	ant.spoel	28	65 W	1,7 Ω	trafo
			175-580m	29	12 W	1 Ω	GK 513 99
			GK 567 62	30	93 W	2 Ω	antibrom-
10	200 W	15 Ω	ant.spoel				spoel
			720-2000m				GK 567 30
			GK 567 63	31	400 per.		luidspreker
11	42 W	< 1 Ω	osc.spoel				LS 13 09 06
12	5 W	< 1 Ω	13,5-52m	32	802 W	55 Ω	M.F.filter
13	11 W	< 1 Ω	GK 568 70	33	196 W	9 Ω	A3 126 85
14	27 W	< 1 Ω	osc.spoel				
15	5 W	< 1 Ω	13,5-42m				
16	9 W	< 1 Ω	GK 568 53				
17	7,5 W	1,5 Ω	osc.spoel	L 1	8003 D	schaalverlichtings-	
18	25 W	4,5 Ω	40-140m			lampje	
			GK 567 78			12 V 100 mA	
19	21 W	1,7 Ω	osc.spoel	G 1	GK 977 69	} schakelaarsegmenten	
20	80 W	4,8 Ω	175-580m	G 2	GK 977 43		
			GK 568 20	G 3	GK 977 32		

C o n d e n s a t o r e n

C 1	1000 pF	E 202 20/1K	C24	10-50 pF	82754/50E
2	4000 pF	E 222 10/4K	25	120 pF	E 103 10/120E
3	470 pF	E 360 05/470E	26	100 pF	E 360 02/100E
4	22000 pF	E 202 10/22K	27	220 pF	E 360 02/220E
5	3000 pF	E 360 05/3K	28	10000 pF	E 105 50/10K
6	27 pF	E 103 10/27E	29	22000 pF	E 105 50/22K
7	10-50 pF	82754/50E	30	0,1 μ F	E 201 10/100K
8	1-6 pF	82754/6E	31	100 pF	E 360 02/100E
9	1-6 pF	82754/6E	32	220 pF	E 360 02/220E
10	10-489 pF)		33	100 pF	E 103 10/100E
11	12-507 pF)	GK 210 56	34	10000 pF	GK 198 42
12	12 pF	E 101 05/12E	35	6800 pF	E 105 50/6K8
13	270 pF	E 360 05/270E	36	3000 pF	E 210 10/3K
14	47 pF	E 103 10/47E	37	220 pF	E 103 10/220E
15	10000 pF	E 105 50/10K	38	0,1 μ F	E 201 10/100K
16	470 pF	E 103 10/470E	39	10000 pF	GK 198 42
17	50 μ F)		40	22000 pF	E 202 10/22K
18	50 μ F)	GK 180 32	41	3-30 pF	7864/01
19	120 pF	E 103 05/120E	42	1-6 pF	82754/6E
20	445 pF	E 360 01/445E	43	6-25 pF	82754/25E
21	195 pF	E 360 02/195E	44	6-25 pF	82754/25E
22	6-25 pF	82754/25E	45	1600 pF	E 360 05/1K6
23	10-50 pF	82754/50E			

W e e r s t a n d e n

R 1	180 Ω	GK 790 08 draadweerstand type GL	R 9	1000 Ω	GK 776 10/1K
2	700 Ω	GK 790 32 draadweerstand type H	10	8200 Ω	GK 777 10/8K2
3	220 Ω	100 026/01	11	2,2 M Ω	GK 776 10/2M2
4	150 Ω	GK 776 10/150E	12	0,27 M Ω	GK 776 10/270K
5	33000 Ω	GK 776 10/33K	13	33000 Ω	GK 776 10/33K
6	15000 Ω	GK 777 10/15K	14	0,1 M Ω	GK 776 10/100K
7	1200 Ω	GK 778 10/1K2	15	2 M Ω	GK 809 39 koolpotmeter log. met schakelaar
8	1 M Ω	GK 776 10/1M	16	10 M Ω	GK 776 10/10M
			17	0,22 M Ω	GK 776 10/220K
			18	0,1 M Ω	GK 776 10/100K
			19	0,82 M Ω	GK 776 10/820K
			20	1000 Ω	GK 776 10/1K
			21	180 Ω	GK 777 10/180E

FIG. 1

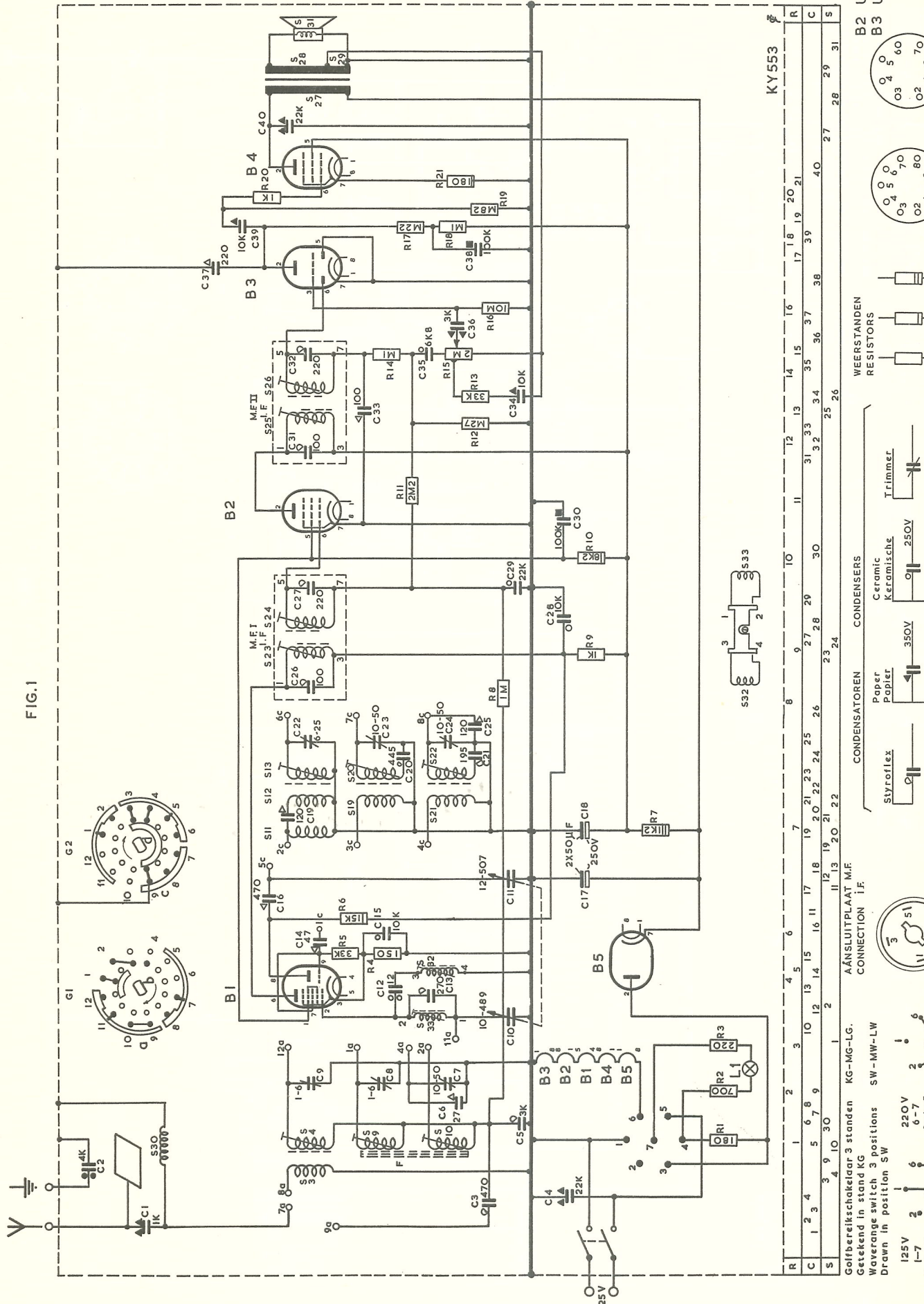

R	1	2	3	4	5	6	7	8	9	10	11	12	13	14	15	16	17	18	19	20	21	R
C	1	2	3	4	5	6	7	8	9	10	11	12	13	14	15	16	17	18	19	20	21	C
S	1	2	3	4	5	6	7	8	9	10	11	12	13	14	15	16	17	18	19	20	21	S

CONDENSATOREN
 Paper
 Papier
 Styroflex
 350V
 400V
 600V
 500V

CONDENSERS
 Ceramic
 Keramische
 250V
 350V
 500V

WEERSTANDEN
 RESISTORS
 0.5W
 1W
 2W

TRIMMERS
 Trimmer

AANSLUITPLAAT M.F. CONNECTION I.F.

Goelberichtschakelaar 3 standen KG-MG-LG.
 Getekend in stand KG
 Wavrange switch 3 positions SW-MW-LW
 Drawn in position SW
 125V 1-7 250V 6-7
 3-5-6 2-4-5

BI UCH 81

B2 UF 41
B3 UBC41

B4 UL 41
B5 UY 41

FIG. 1

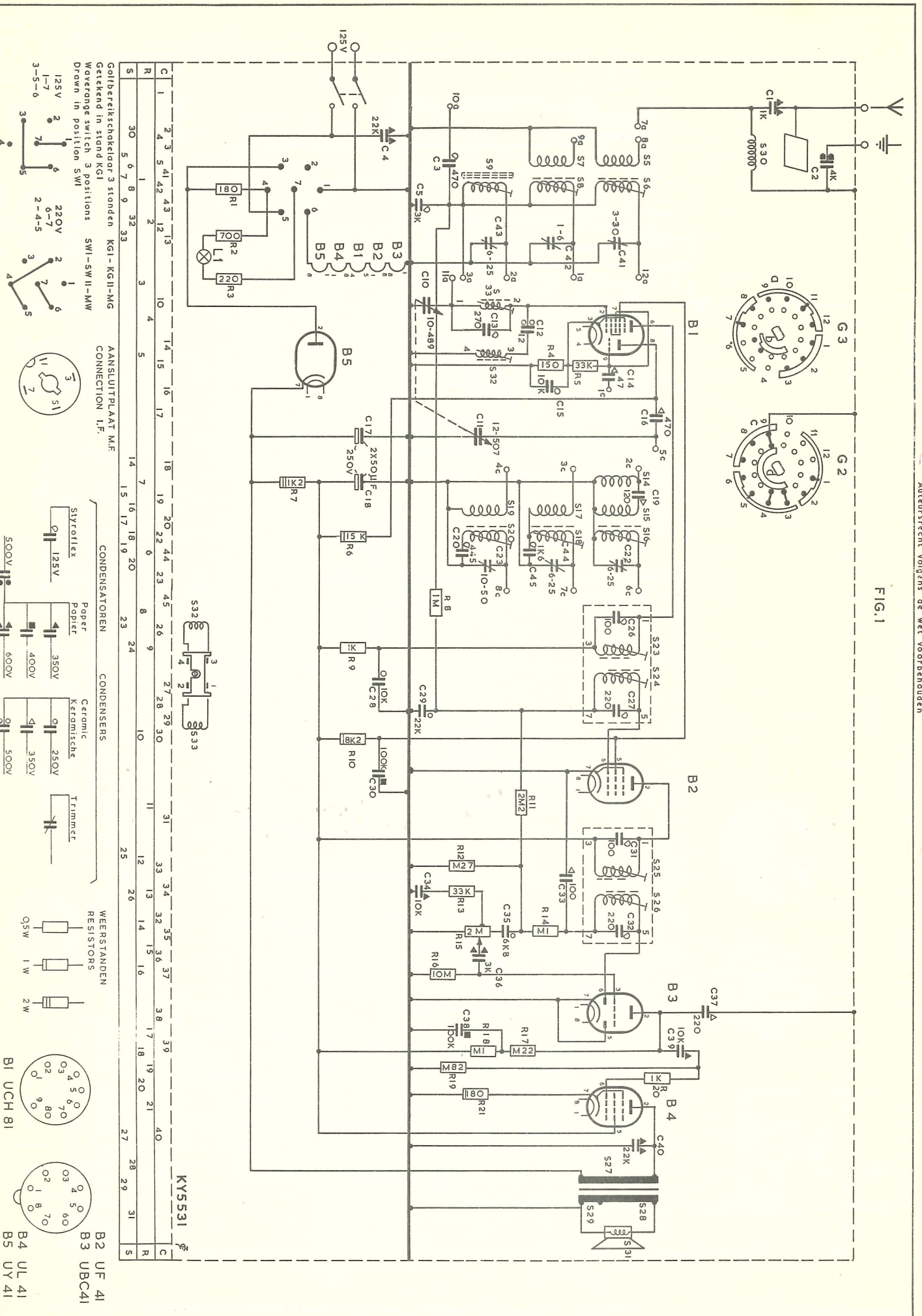
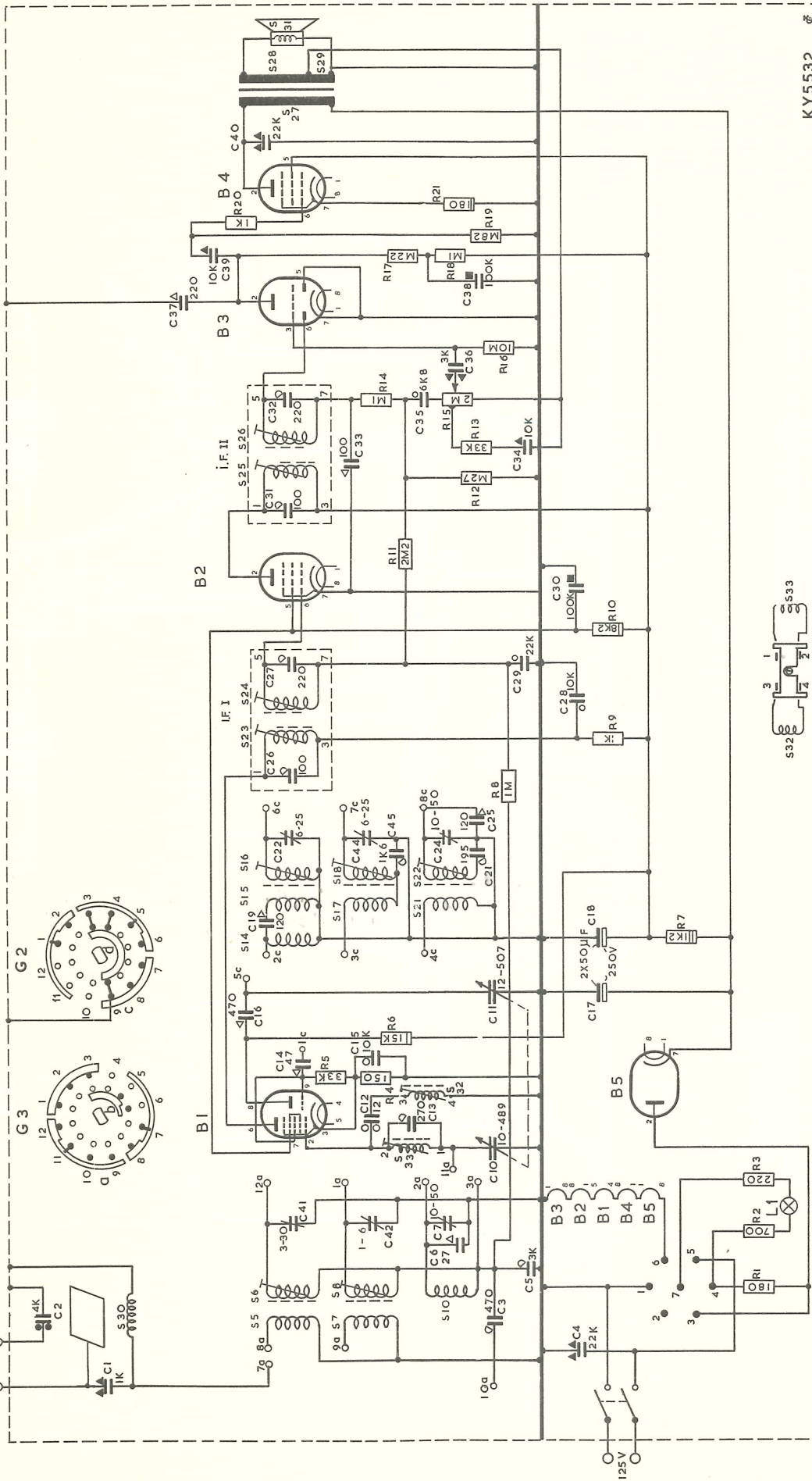

FIG. 1



KY5532

R	1	2	3	4	5	6	7	8	9	10	11	12	13	14	15	16	17	18	19	20	21
C	1	2	3	4	5	6	7	8	9	10	11	12	13	14	15	16	17	18	19	20	21
S	1	2	3	4	5	6	7	8	9	10	11	12	13	14	15	16	17	18	19	20	21

Golfschakelaar 3 standen KGI-KGII-LG
Getekend in stand KG
Wavering switch 3 positions SWI-SWII-LW
Drawn in position SW

ANSLUITPLAAT M.F.
CONNECTION I.F.

CONDENSATOREN
 Paper
 Papier
 Styroflex
 125V
 500V
 350V
 400V
 600V

CONDENSERS
 Ceramic
 Keramische
 250V
 350V
 500V

WEERSTANDEN
RESISTORS
 0.5W
 1W
 2W

B1 UCH 81
B2 UBC41
B3 UF 41
B4 UL 41
B5 UY 41

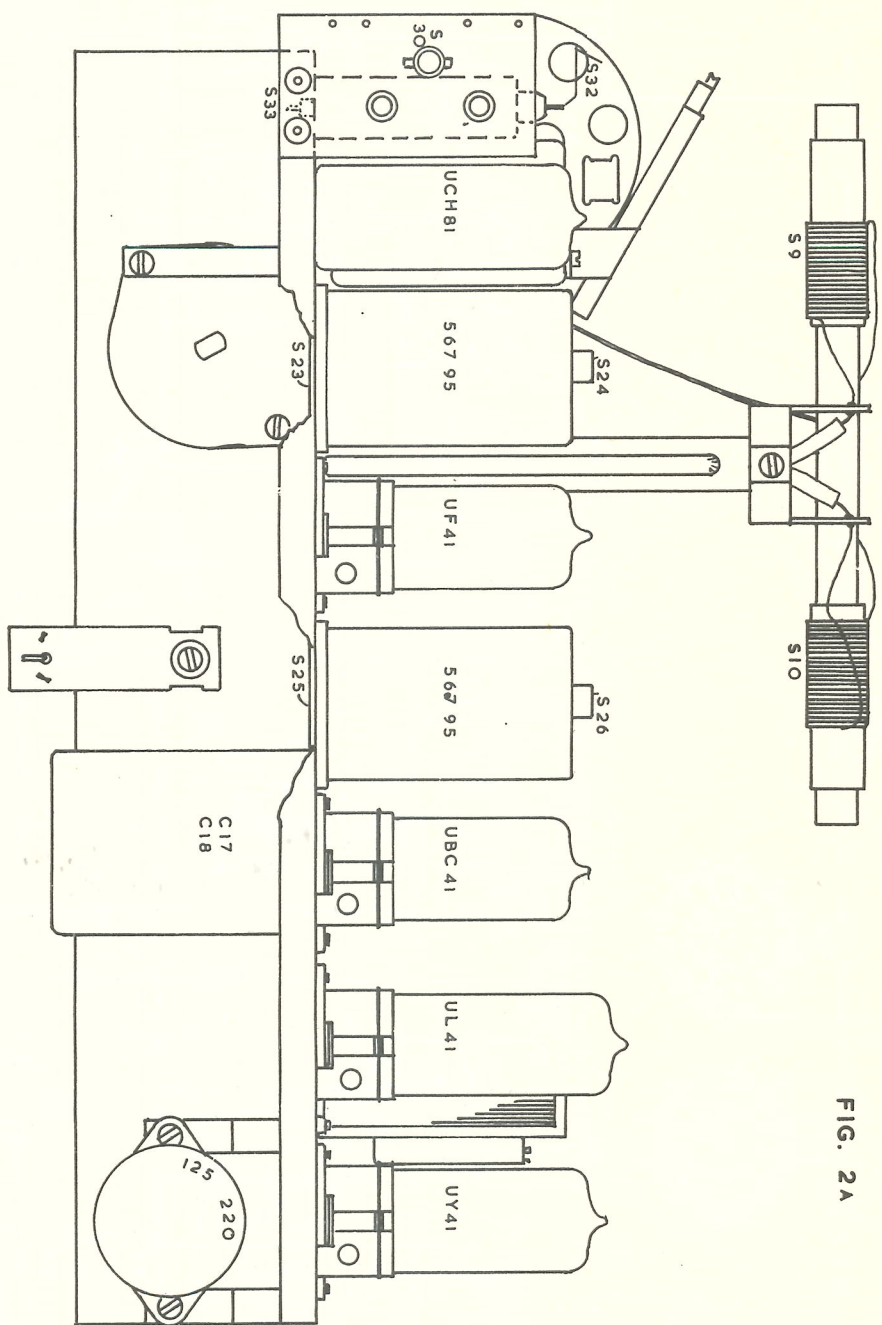
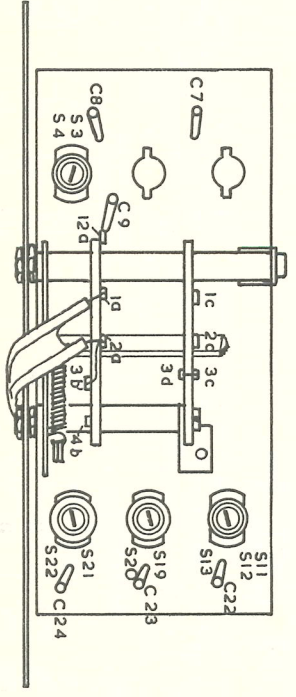
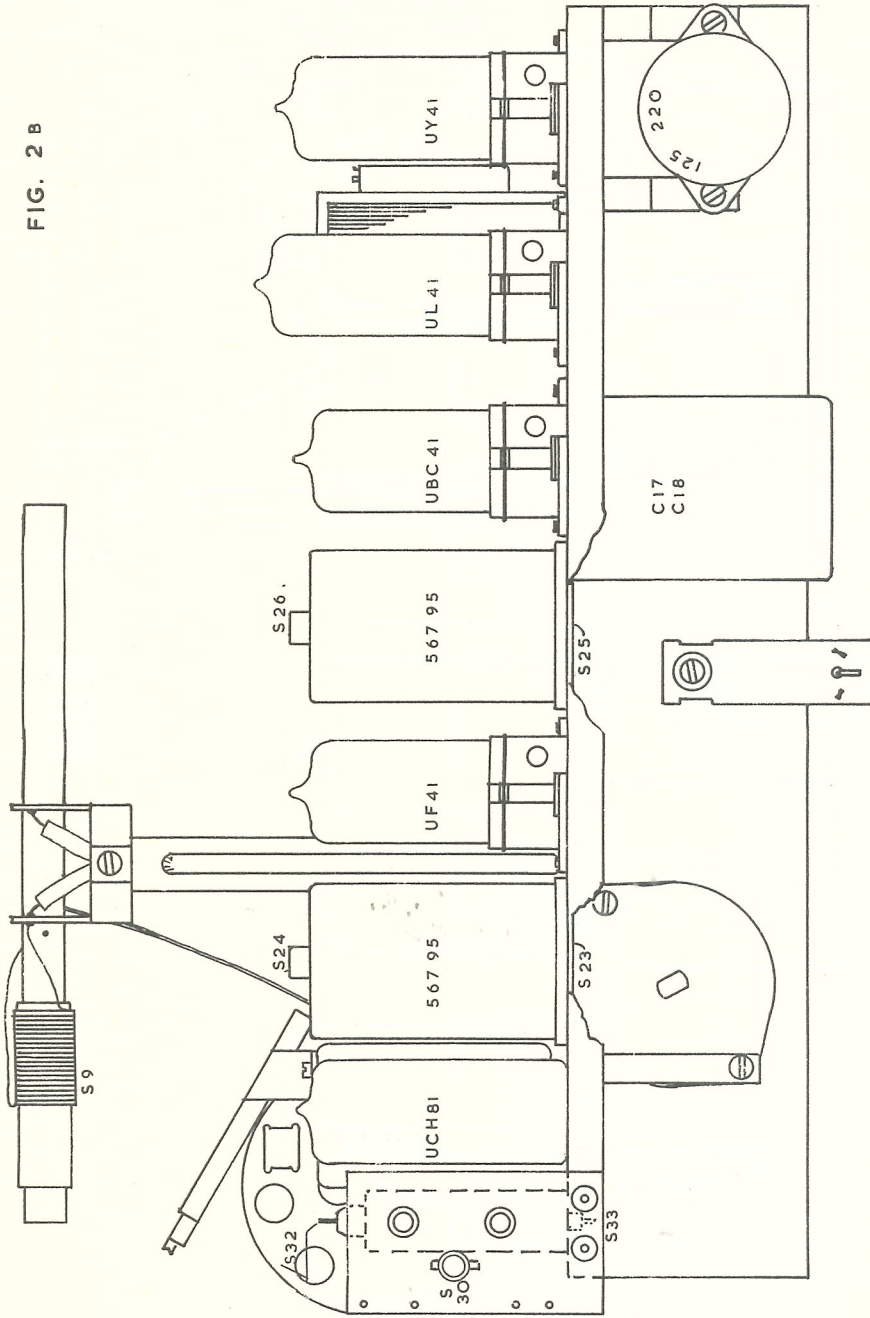

FIG. 2A



Trimmschema
Adjust diagram

FIG. 2 B



Trimschema
Adjust diagram

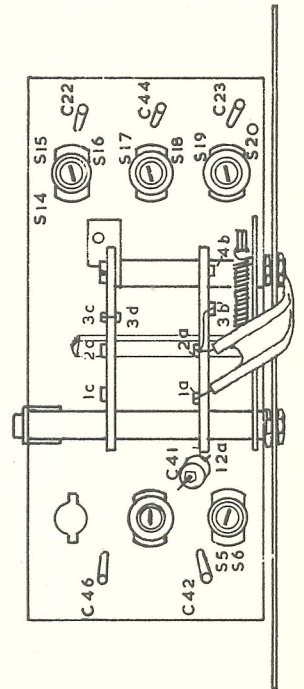

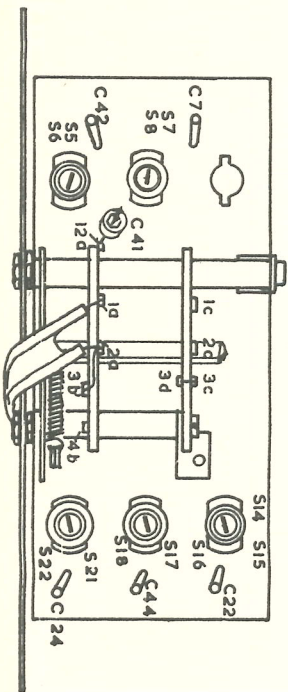
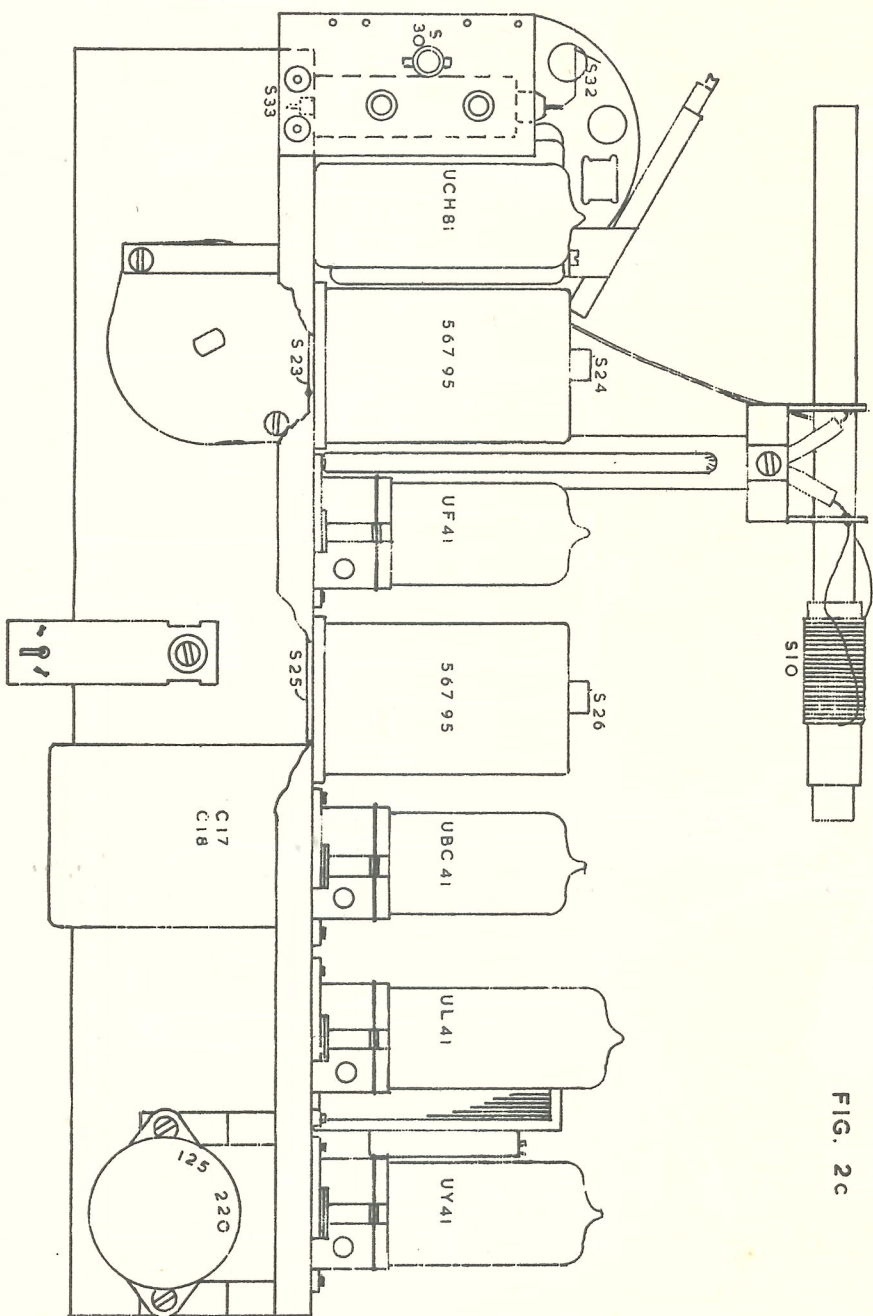
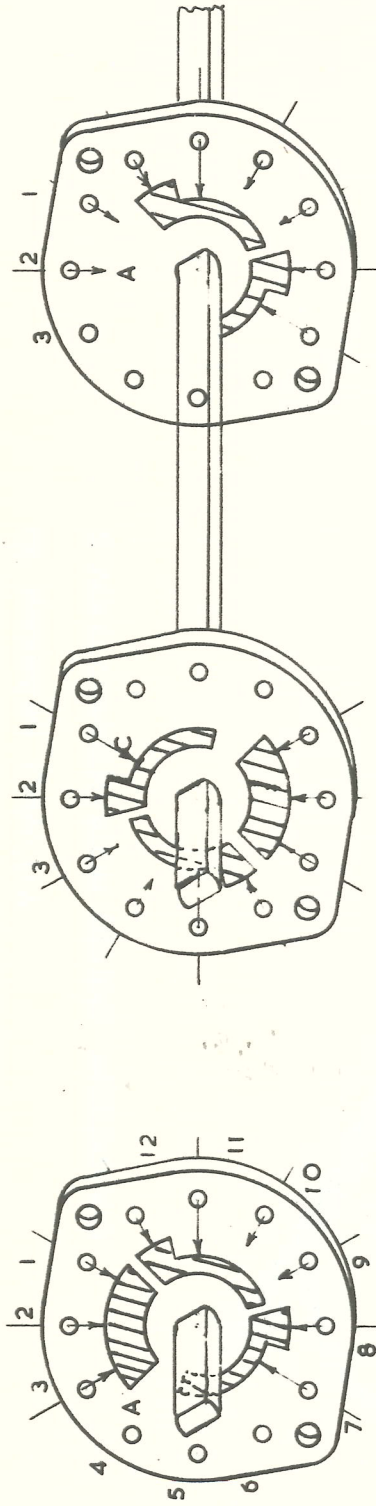

FIG. 3



G1

GK 977 69

G2

GK 977 43

G3

GK 977 42

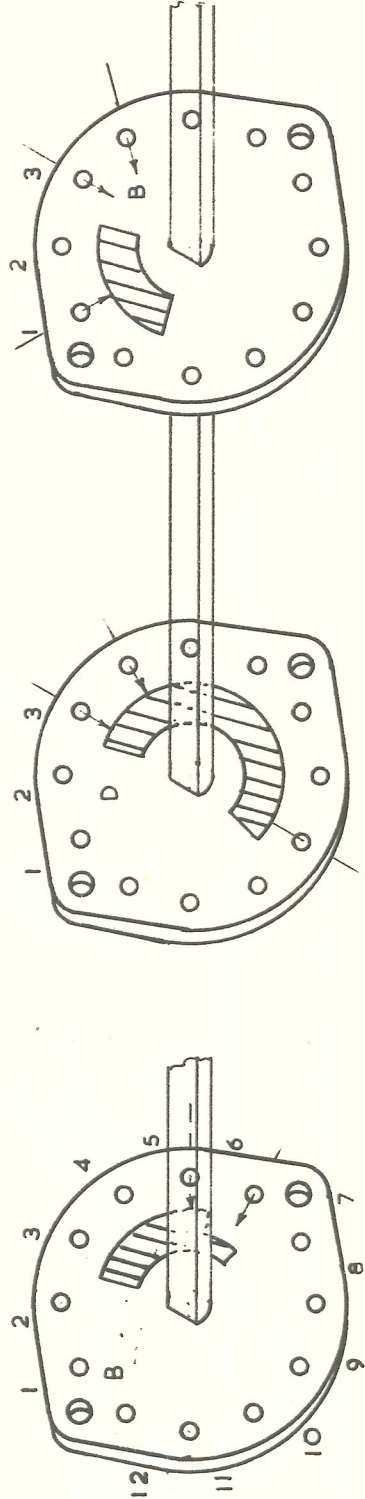

SHOWN IN POSITION SW (SW I)

VARIABLE CONDENSER IN POSITION
OF MAXIMUM CAPACITY

FIG.4

2-VOUD. CONDENSATOR GEHEEL INGEDRAAID

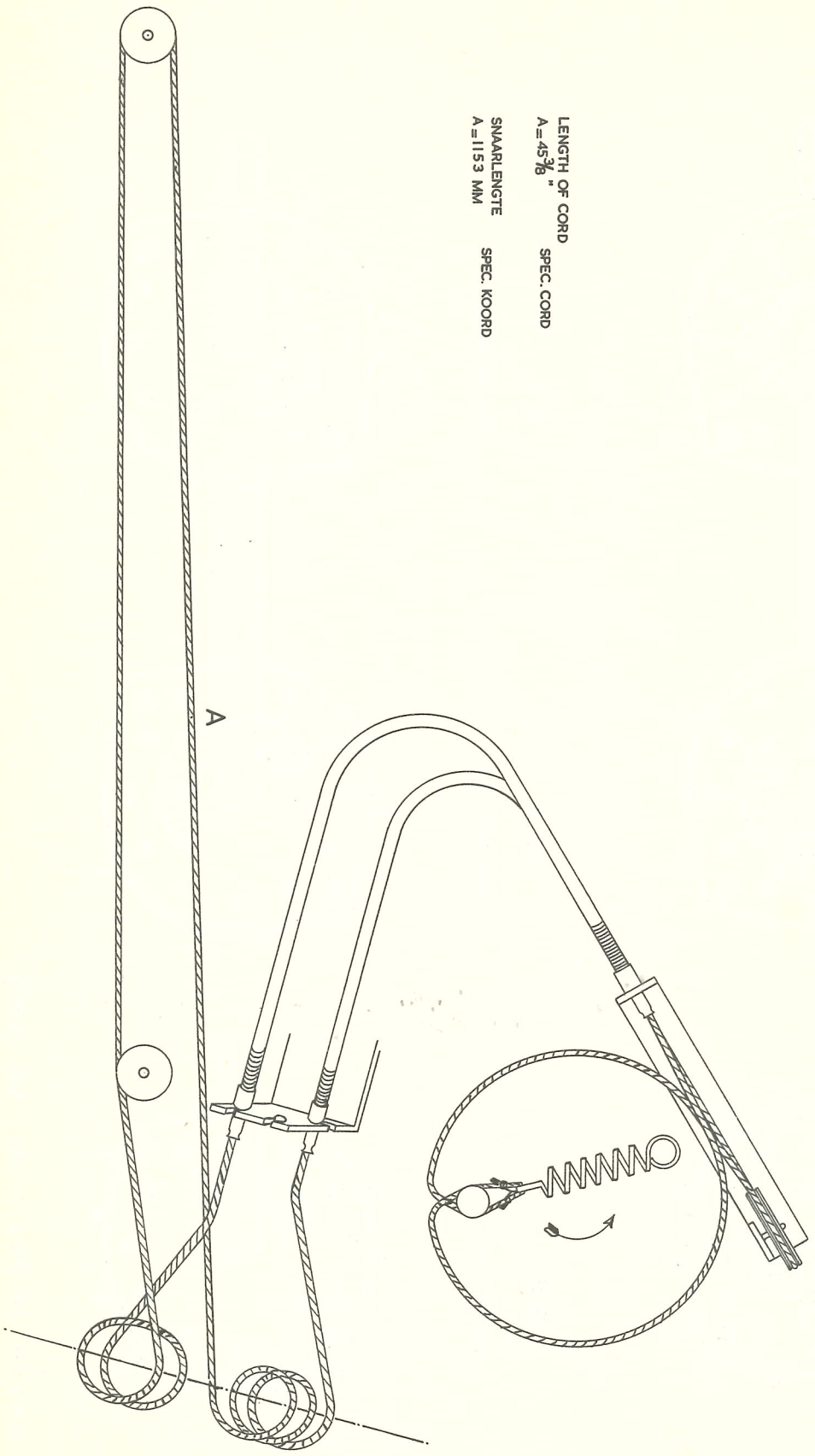

LENGTH OF CORD
A = 45 3/8"

SPEC. CORD
SPEC. KOORD

SMARLENGTE
A = 1153 MM